

**MSUD VALVE PLUG FORM A 18MM**

PUR 3X0.75 black UL/CSA, drag ch 7m

MSUD

Form A (18 mm)

24 V AC  $\pm 20\%$  / DC  $\pm 25\%$

LED and suppression

Bridged PE

Further cable lengths on request.

Plastic housings with good resistance against chemicals and oils.

The resistance to aggressive media should be individually tested for your application. Further details on request.

**Illustration**

stay connected



Height: 30 mm

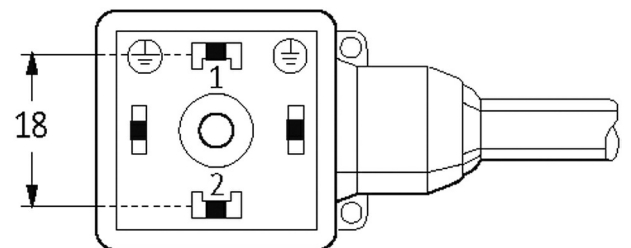
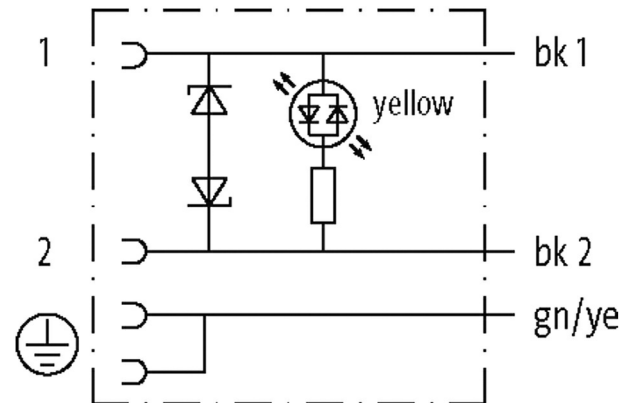

Product may differ from Image

**Approvals**

cCSAus

\* only for products with UL/GSA approved cable

**Form**

Form

18021

Cables	
No./diameter of wires	3× 0.75 mm <sup>2</sup>
Wire isolation	PP (bk num, gnye)
C-track properties	10 Mio.
Material (jacket)	PUR (UL/CSA)
Outer Ø	5.9 mm ±5%
Bend radius (moving)	10× outer Ø
Temperature range (fixed)	-40...+80 °C
Temperature range (mobile)	-25...+80 °C
Cable identification	636
Cable Type	3 (PUR)
Approval (cable)	cURus (AWM-Style 20549/10493); CE conform
Cable weight [g/m]	56,10
Material (wire)	Cu wire, bare
Resistor (core)	max. 26 Ω/km (20 °C)
Single wire Ø (core)	0.15 mm
Construction (core)	42× 0.15 mm (multi-strand wire class 6)
Diameter (core)	3× 0.75 mm <sup>2</sup>
AWG	similar to AWG 18
Material (wire isolation)	PP
Material property (wire isolation)	CFC-, halogen-, cadmium-, silicone- and lead-free
Shore hardness (wire isolation)	70 ±5 D
Wire-Ø incl. isolation	1.85 mm ±5%
Color/numbering of wires	bk numbered, gnye longitudinally striped
Stranding combination	3 wires twisted
Shield	no
Material (jacket)	PUR
Material property (jacket)	CFC-, halogen-, cadmium-, silicone- and lead-free, matt, low-adhesion, machine easy to process, abrasion-resistant, hydrolysis and microbial resistant
Shore hardness (jacket)	90 ±5 A
Outer-Ø (jacket)	5.9 mm ±5%
Color (jacket)	black
chemical resistance	good resistance to oil, gasoline and chemicals (EN 60811-404)
thermal resistance	flame retardant UL 1581 VW1 / CSA FT1 / IEC 60332-1, IEC 60332-2-2
Nominal voltage	300 V AC
Test voltage	2500 V AC
Current load capacity	to DIN VDE 0298-4
Temperature range (fixed)	-40...+80 °C, (+90 °C at max. 10 000 operating hours)
Temperature range (mobile)	-25...+80 °C, (+90 °C at max. 10 000 operating hours)
Bend radius (fixed)	5× outer Ø
Bend radius (moving)	10× outer Ø
No. of bending cycles (C-track)	max. 10 Mio. (25 °C)
Travel speed (C-track)	max. 3 m/s
Acceleration (C-track)	max. 10 m/s <sup>2</sup>
Torsion stress	±180°/m
No. of torsion cycles	max. 2 Mio. (25 °C)
Torsion speed	35 cycles/min
Jacket Color	black
Technical Data	
Operating voltage	24 V AC ±20% / DC ±25%
Rated surge voltage	0.8 kV

Operating current per contact	max. 4 A
Current consumption	max. 15 mA
Material group	IEC 60664-1, category I
Switch off peak	max. 55 V
Switch off delay time	max. 20 ms
LED display	yellow
Locking of ports	M3 (recommended torque 0.4 Nm)
Protection	IP67 inserted and tightened (EN 60529)
Locking material	Steel (galvanized)
Material	PBT
Housing	Black plastic (gray on request)
Additional suppressor	Diode/Z-Diode

**General data**

Pollution Degree	3
Material (gasket)	PUR
Temperature range	-25...+85 °C, depending on cable quality

**Commercial data**

country of origin	CZ
customs tariff number	85444290
EAN	4048879193467
eClass	27279218
Packaging unit	1